

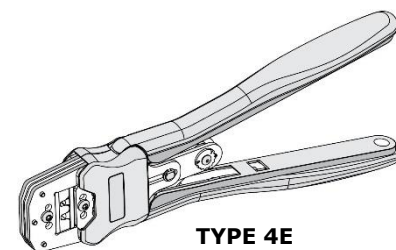

Order No. 200218-0900

## Application Tooling Specification



### FEATURES

- A full-cycle ratcheting hand tool ensures complete crimps
- Ergonomic soft grip handles for comfortable crimping
- A precision user-friendly terminal locator wire stop holds terminals in the proper crimping position
- Right- and left-handed applications
- This tool is IPC/WHMA-A-620 Class 2 compliant

### SCOPE

**Products:** Mega-Fit Male and Female Terminals crimped to 12 AWG wire.

Terminal Series No.	Terminal Order No. (3)	Wire Size		Insulation Diameter				Strip Length	
				IPC/WHMA-A-620 (1)		Terminal (2)			
		AWG	Wire Type	mm	In.	mm	In.	mm	In.
105417	105417-0314 105417-0324	12	UL1007	3.12-3.42	.123-.135	4.11 max	.162 max	5.0-5.5	.197-.217
			UL1015	3.75-4.05	.148-.159				
76823	76823-0314 76823-1314 76823-0324	12	UL1007	3.12-3.42	.123-.135	4.11 max	.162 max	5.0-5.5	.197-.217
			UL1015	3.75-4.05	.148-.159				

(1) To achieve optimum IPC/WHMA-A-620 insulation crimps, use this insulation OD range.  
 (2) Overall insulation OD specification for terminal.  
 (3) Reeled terminals; when cutting terminal from strip, cut-off tab not to exceed 0.5mm (.020").

### DEFINITION OF TERMS

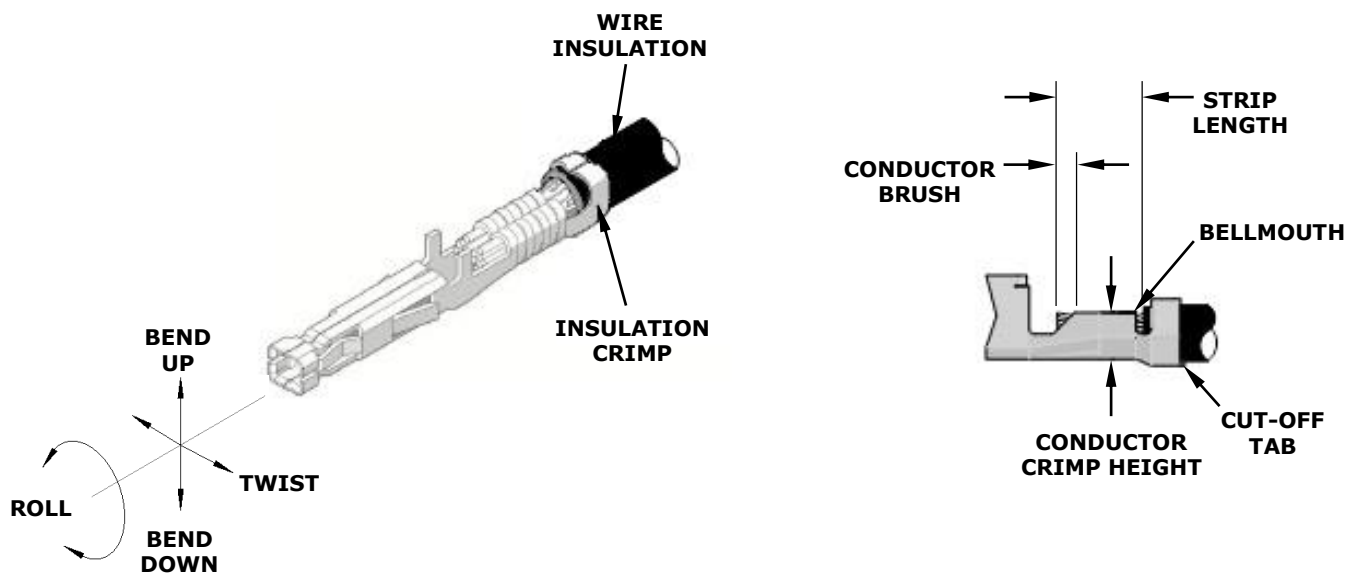

**CRIMP SPECIFICATION**

Terminal Series No.	Bell Mouth		Conductor Brush	
	mm	In.	mm	In.
105417 76823	0.40-0.75	.016-.023	0.10-1.15	.004-.045

Terminal Series No.	Bend Up	Bend Down	Twist	Roll	Seam
	Degrees Max.		Degrees Max.		
105417 76823	3	3	4	8	Seam shall not be open and no wire allowed out of the crimping area

After crimping, the crimp profiles should measure the following:

Terminal Series No.	Wire Size AWG	Wire Type UL Style	Conductor Crimp				Pull Force Minimum		Profile	
			Height		Width		N	Lb.	A	B
			mm	In.	mm	In.				
105417	12	1007	1.90-2.00	.075-.079	3.20-3.30	.126-.130	222	49.9		X
		1015							X	
76823	12	1007	1.90-2.00	.075-.079	3.20-3.30	.126-.130	222	49.9		X
		1015							X	

Terminal Series No.	Wire Size AWG	Wire Type UL Style	Insulation Crimp				Profile	
			Height (Ref)		Width (Ref)		A	B
			mm	In.	mm	In.		
105417	12	1007	4.0	.157	3.8	.150		X
		1015	4.05	.159	4.45	.175	X	
76823	12	1007	4.0	.157	3.8	.150		X
		1015	4.05	.159	4.45	.175	X	

**Tool Qualification Notes**

1. Pull force should be measured with no influence from the insulation crimp.
2. The above specifications are guidelines to an optimum crimp.

**CAUTION:** Install only Molex terminals listed above with this tool. Do not crimp hardened objects as damage can occur to the tool frame or crimping die.

**Note**

A crimp height chart is provided with this document as a reference only. Because of the wide range of wires, strands, insulation diameters and durometers available, actual crimp height measurements may vary slightly. An occasional destructive pull force test should be performed to check hand tool crimp. Pull force value must exceed the minimum pull force specifications listed.

## OPERATION

Open the tool by squeezing the handles together. At the end of the closing stroke, the ratchet mechanism will release the handles and the hand tool will spring open. See Figure 1.

### Crimping Terminals

1. Select the desired terminal listed in the preceding charts.
2. Squeeze the back of the locator to raise the wire stop before inserting the terminal into the hand tool. See Figure 2.
3. With the locator open, load the terminal into the proper nest opening marked with the wire gauge on the hand tool. See Figure 2.
4. Next, release the locator, allowing the wire stop to return to the crimping position.
5. Insert the properly-stripped wire through the terminal and against the wire stop. See Figure 3.

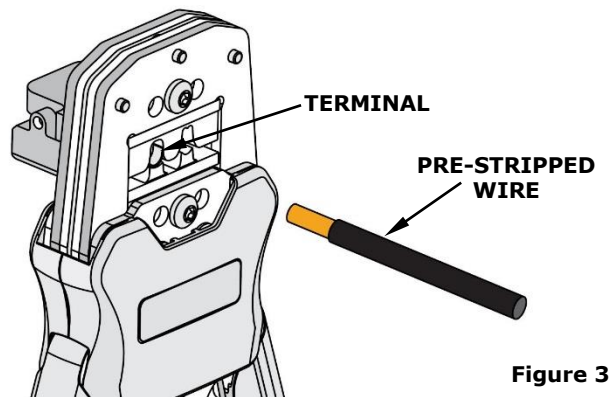
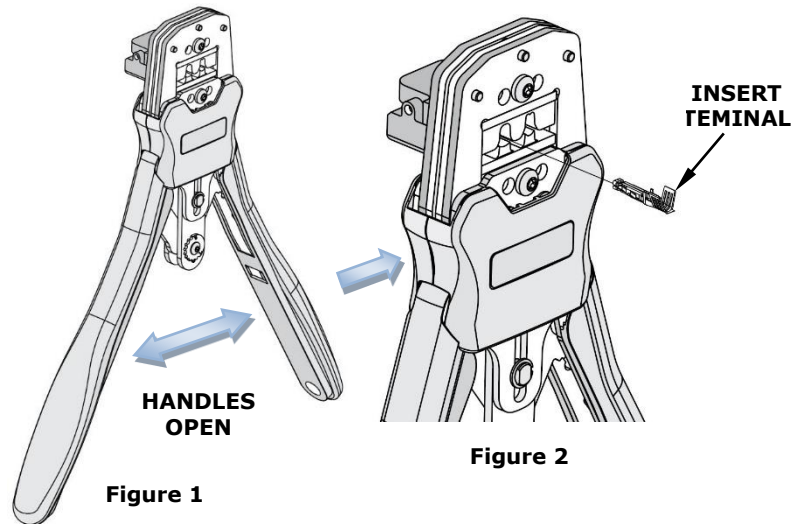

6. Crimp the terminal by squeezing the tool handles until the ratchet mechanism cycle has been completed. Release the handles to open the jaws. See Figure 4.

**Note:** The tamper-proof ratchet action will not release the tool until it has been fully closed.

7. Squeeze the locator lever to raise the wire stop, and remove the crimped terminal from the locator by lifting up and then pulling the wire out.
8. Visually inspect the crimped terminal for proper crimp location.

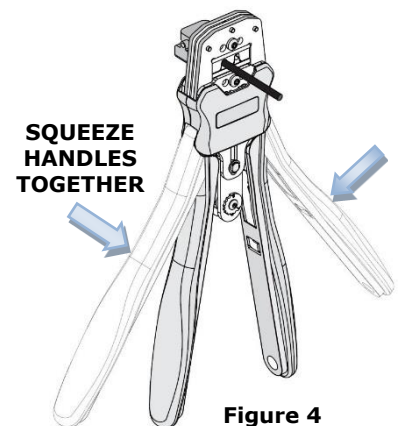

## LOCATOR REPLACEMENT

See the parts list on the last page of this document for the proper locator order number. Follow the steps below to replace the locator:

1. Open the crimp hand tool and rotate the tool so that its face is pointing down and the locator is facing up.
2. Remove the tightening lock nut.

3. Remove the locator assembly from the frame head.
4. To reinstall the new locator, make sure the hand tool is in the open position.
5. Replace the locator assembly into the frame head.
6. Reinstall the tightening lock nut.

### Remove and Install Tooling

1. Make sure the tool is in open position before removing or install tooling.
2. The locator must be removed before removing or installing tooling.
3. Remove the M4 screw that holds the upper tooling.
4. Remove or install upper tooling through the back side of the tool frame.
5. Install the M4 screw. Make sure the small markings on the front of the hand tool frame match up. See Figure 5.
6. To replace the lower tooling, follow steps 3–5. You must remove or install the lower tooling through the front side of the tool frame. Be sure the small markings on the lower tooling line up with upper tooling.
7. Slowly close the tool handles to align the upper and lower tooling. Tighten the M4 screws and continue squeezing the tool handles until the hand tool swings open.
8. Reinstall the locator by following the instructions in the locator replacement section.

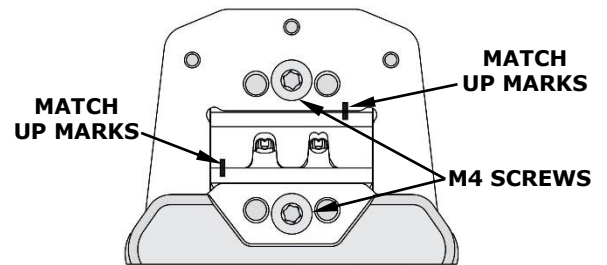

Figure 5

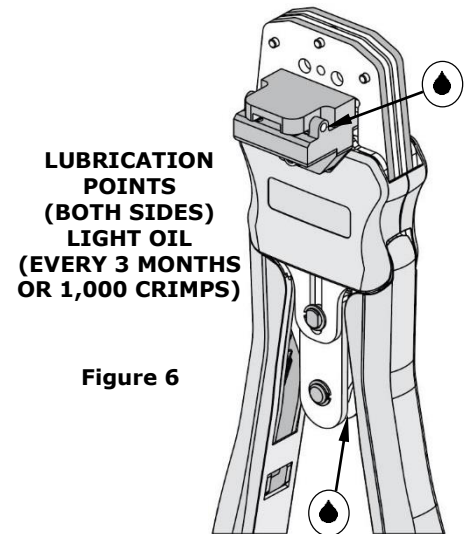

Figure 6

## MAINTENANCE

It is recommended that each operator of the tool be made aware of and responsible for the following maintenance steps: See Figure 6.

1. Un-snap the two snap-on plastic covers (front and back).
2. Remove dust, moisture and other contaminants with a clean brush or a soft, lint-free cloth.
3. Do not use any abrasive materials that could damage the tool.
4. Make certain all pins, pivot points and bearing surfaces are protected with a thin coat of high-quality machine oil. Do not oil excessively. The tool was engineered for durability, but like any other equipment, it needs cleaning and lubrication for a maximum service life of trouble-free crimping. Light oil such as 30 weight automotive oil used at the oil points every 1,000 crimps or 3 months will significantly enhance the tool life.
5. Wipe excess oil from the hand tool, particularly from the crimping area. Oil transferred from the crimping area onto certain terminations may affect the electrical characteristics of an application.
6. When the tool is not in use, keep the handles closed to prevent objects from becoming lodged in the crimping dies, and store the tool in a clean, dry area.

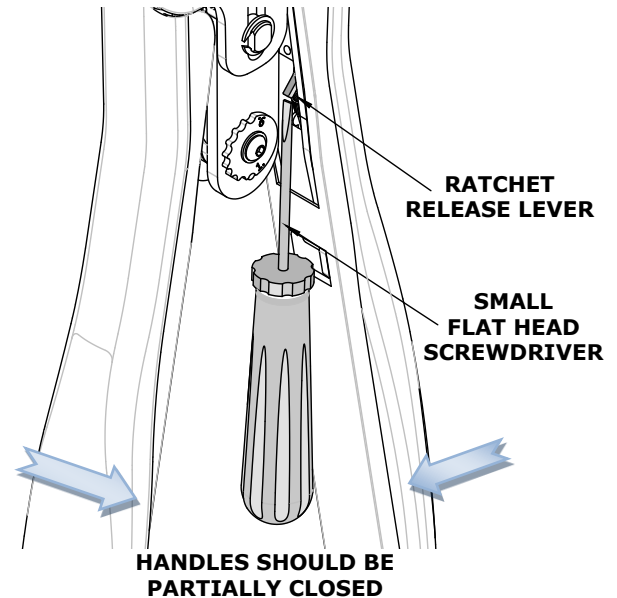

Figure 7

### Miscrimps or Jams

Should this tool ever become stuck or jammed in a partially closed position, **Do Not** force the handles open or closed. The tool will open easily by pressing up on the ratchet release lever in the movable handle. See Figure 7.

### HOW TO ADJUST TOOL PRELOAD (See Figure 8)

This hand tool is factory preset to 210 N (47 pounds) preload. It may be necessary over the life of the tool to adjust tool handle preload force. Listed below are the steps required to adjust the crimping force of the hand tool to obtain proper crimp conditions:

1. Open the tool by squeezing the handles together until the ratchet mechanism releases. The hand tool handles will spring open.
2. Remove the M3 screw and the M3 washer.
3. Lift the setting wheel off the axle. Use a small flat head screwdriver to turn the eccentric axle counterclockwise (CCW) to increase the handle force.
4. To decrease the handle force, turn the eccentric axle clockwise (CW).
5. Line up the setting wheel matching the flat side with the flat edge of the axle so the wheel notch will drop onto the roll pin. The numbers will display higher.
6. Re-install the M3 washer and M3 screw.
7. Re-crimp a new sample and check the crimp specifications or conduct a pull test after tool handle preload force is adjusted.

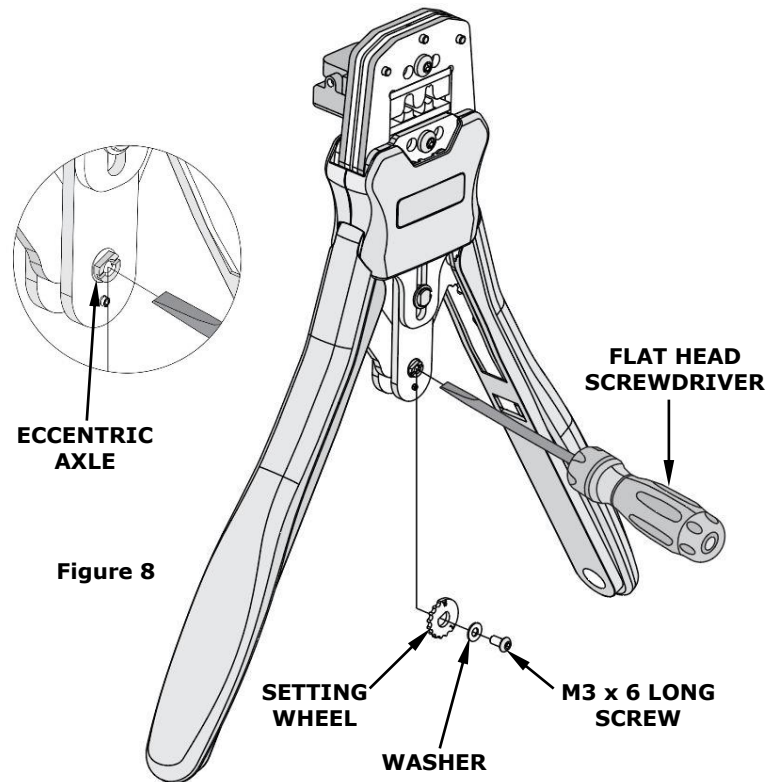

### Warranty

This tool is for electrical terminal crimping purposes only. This tool is made of the best quality materials. All vital components are long-life tested. All tools are warranted to be free of manufacturing defects for a period of 30 days. Should such a defect occur, Molex will repair or exchange the tool free of charge. This repair or exchange will not be applicable to altered, misused or damaged tools. This tool is designed for hand use only. Any clamping, fixturing or use of handle extensions voids this warranty.

**CAUTION:** Molex crimp specifications are valid only when used with Molex terminals and tooling.

## CAUTIONS

---

1. Manually powered hand tools are intended for low-volume use or field repair. This tool is **NOT** intended for production use. Repetitive use of this tool should be avoided.
2. Insulated rubber handles are not protection against electrical shock.
3. Wear eye protection at all times.
4. Use only the Molex terminals specified for crimping with this tool.

## CERTIFICATION

---

Molex does not certify or re-certify hand tools but rather supplies the following guidelines for customers to re-certify hand tools:

- This tool is qualified to pull force only. See the Molex website for the Quality Crimp Handbook for more information on pull testing.
- If the tool does not meet minimum pull force values, handle preload should be increased, and the pull test should be rerun (See How to Adjust Preload).
- When the hand tool is no longer capable of achieving minimum pull force, it should be taken out of service and replaced.

**PARTS LIST**

Item Number	Order Number	Description	Quantity
REF	200218-0900	Hand Crimp Tool	Figure 9
1	200218-0975	Locator Assembly	1
2	63810-0106	Spring, Ratchet	1

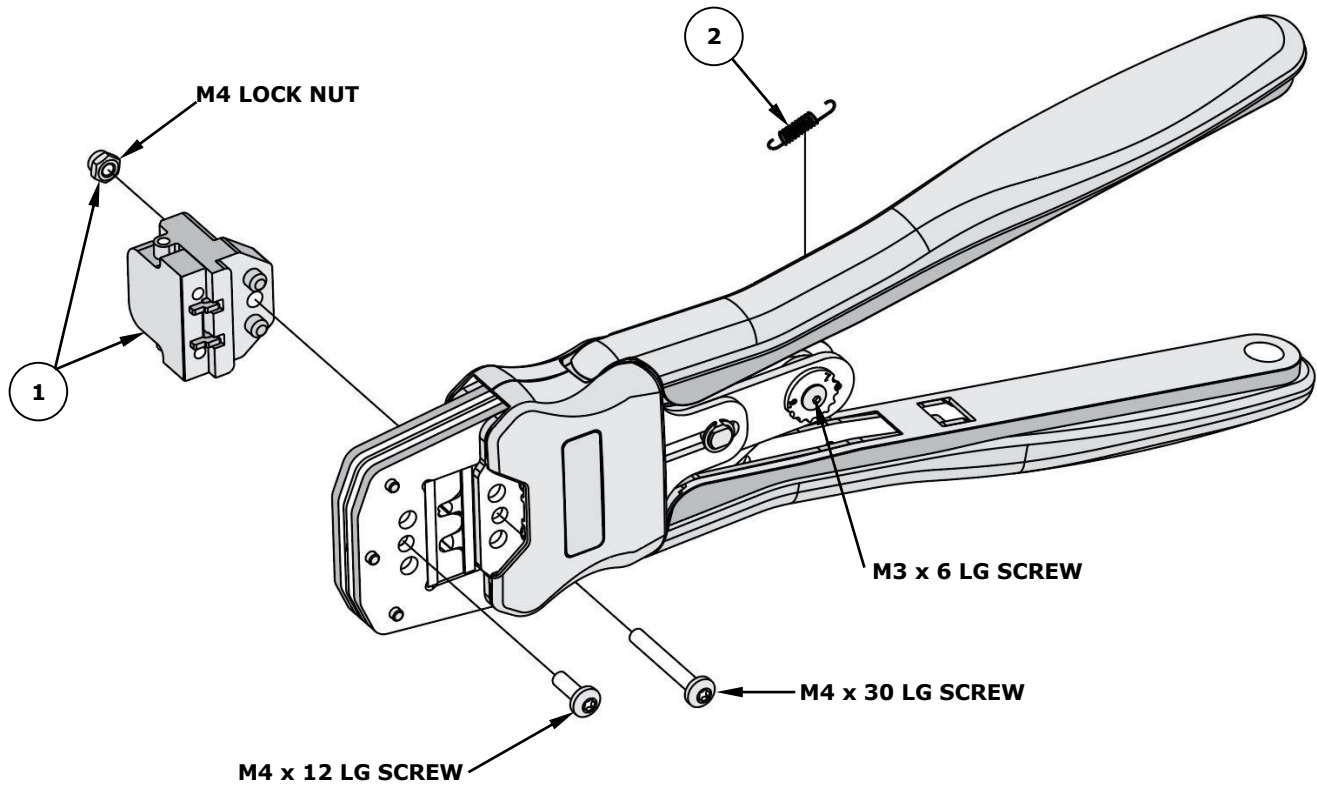

Figure 9

**Application Tooling Support**

**Phone:** (402) 458-TOOL (8665)  
**E-Mail:** applicationtooling@molex.com  
**Website:** www.molex.com/applicationtooling

Molex is a registered trademark of Molex, LLC in the United States of America and may be registered in other countries; all other trademarks listed herein belong to their respective owners.